

OWNER'S OPERATING MANUAL



WP-42HD

High-Definition LCD Monitor
with WideVision™



THE WORLD'S FINEST HOME THEATRE PRODUCTS™

ONE YEAR LIMITED WARRANTY

For LCD Displays

Congratulations on your purchase of a Runco video product and welcome to the Runco family! We believe Runco produces "The World's Finest Home Theater Products." With proper installation, setup and care, you should enjoy many years of unparalleled video performance.

This is a LIMITED WARRANTY as defined in the Magnuson-Moss Warranty Act. Please read it carefully and retain it with your other important documents.

WHAT IS COVERED UNDER THE TERMS OF THIS LIMITED WARRANTY:

SERVICE LABOR: Runco will pay for service labor by a Runco Authorized Service Center when needed as a result of a manufacturing defect for a period of one (1) year from the effective date of delivery to the end user.

PARTS: Runco will provide new or rebuilt replacement parts for the parts that fail due to defects in materials or workmanship for a period of one (1) year from the effective date of delivery to the end user. Such replacement parts are then subsequently warranted for the remaining portion (if any) of the original warranty period.

WHAT IS NOT COVERED UNDER THE TERMS OF THIS LIMITED WARRANTY:

Image retention on LCD display panels is specifically excluded from coverage under this Limited Warranty. Image retention or staining of an image is the result of misuse of the product and therefore cannot be repaired under the terms of this Limited Warranty.

Normal viewing material such as television/satellite broadcasts, videotape or DVDs (not put into pause for extended periods of time) will not cause damage to your display under normal conditions. Many DVD players are also equipped with screen savers for this reason.

TO AVOID IMAGE RETENTION (Burn-in): Please ensure that still images are not left on your LCD display panel. Also ensure that images displayed in the 4:3 aspect ratio mode (black or gray stripes, but no picture information is present on the left and right edges of the screen) are used as infrequently as possible. This will prevent permanent retention on your LCD display panel, which can be seen permanently under certain conditions once burn-in has occurred.

The types of images to avoid include video games, still images and computer screens with stationary tool bars and icons. (This is why computers are equipped with screen savers – to prevent still images from burning into the monitor's phosphors after being displayed continuously for an extended period of time).

This Limited Warranty only covers failure due to defects in materials and workmanship that occur during normal use and does not cover normal maintenance. This Limited Warranty does not cover cabinets or any appearance items; failure resulting from accident, misuse, abuse, neglect, mishandling, misapplication, faulty or improper installation or setup adjustments; improper maintenance, alteration, improper use of any input signal; damage due to lightning or power line surges, spikes and brownouts; damage that occurs during shipping or transit; or damage that is attributed to acts of God. In the case of remote control units, damage resulting from leaking, old, damaged or improper batteries is also excluded from coverage under this Limited Warranty.

CAUTION: THIS LIMITED WARRANTY ONLY COVERS RUNCO PRODUCTS PURCHASED FROM RUNCO AUTHORIZED DEALERS. ALL OTHER PRODUCTS ARE SPECIFICALLY EXCLUDED FROM COVERAGE UNDER THIS LIMITED WARRANTY. MOREOVER, DAMAGE RESULTING DIRECTLY OR INDIRECTLY FROM IMPROPER INSTALLATION OR SETUP IS SPECIFICALLY EXCLUDED FROM COVERAGE UNDER THIS LIMITED WARRANTY. IT IS IMPERATIVE THAT INSTALLATION AND SETUP WORK BE PERFORMED ONLY BY AN AUTHORIZED RUNCO DEALER TO PROTECT YOUR RIGHTS UNDER THIS WARRANTY. THIS WILL ALSO ENSURE THAT YOU ENJOY THE FINE PERFORMANCE OF WHICH YOUR RUNCO PRODUCT IS CAPABLE WHEN INSTALLED AND CALIBRATED BY RUNCO AUTHORIZED PERSONNEL.

RIGHTS, LIMITS AND EXCLUSIONS

Runco limits its obligations under any implied warranties under state laws to a period not to exceed the warranty period. There are no express warranties. Runco also excludes any obligation on its part for incidental or consequential damages related to the failure of this product to function properly. Some states do not allow limitations on how long an implied warranty lasts, and some states do not allow the exclusion or limitation of incidental or consequential damages. So the above limitations or exclusions may not apply to you. This warranty gives you specific legal rights, and you may also have other rights that vary from state to state.

EFFECTIVE WARRANTY DATE:

This warranty begins on the effective date of delivery to the end user. For your convenience, keep the original bill of sale as evidence of the purchase date.

IMPORTANT – WARRANTY REGISTRATION:

Please fill out and mail your warranty registration card. It is imperative that Runco knows how to reach you promptly if we should discover a safety problem or product update for which you must be notified.

CONTACT A RUNCO AUTHORIZED SERVICE CENTER TO OBTAIN SERVICE:

Repairs made under the terms of this Limited Warranty covering your Runco video product will be performed at the location of the product, during usual working hours, providing location of product is within normal operating distance from a Runco Authorized Service Center. In some instances it may be necessary for the product to be returned to the Runco factory for repairs. If, solely in Runco's judgment, location of product to be repaired is beyond normal operating distance of the closest Runco Authorized Service Center, or the repair requires the unit be returned to the Runco factory, it is the owner's responsibility to arrange for shipment of the product for repair. These arrangements must be made through the selling Runco Dealer. If this is not possible, contact Runco directly for a Return Authorization number and shipping instructions. Runco will return product transportation prepaid in the United States, unless no product defect is discovered. In that instance, shipping costs will be the responsibility of the owner.

COPYRIGHT AND TRADEMARKS:

© Copyright 2007 Runco International. This document contains proprietary information protected by copyright, trademark and other intellectual property laws. All rights are reserved. No part of this manual may be reproduced by any mechanical, electronic or other means, in any form, without prior written permission of the manufacturer.

Reflection, Enhanced GEN3, DHD, Vivix, Virtual Cinema, CineWide, AutoScope, O-Path, CinOptx, LiveLink, CSMS, SuperOnyx and VirtualWide are trademarks of Runco International. All other trademarks and registered trademarks used in this document are the property of their respective owners.

Runco International products are manufactured under one or more of the following patents: US. Patent 6755540 and Other Patents Pending.

ADDITIONAL INFORMATION:

To locate the name and address of the nearest Runco Authorized Service Center, or for additional information about this Limited Warranty, please call or write:

RUNCO INTERNATIONAL, INC.
Attn: Customer Service Department
2900 Faber Street
Union City, CA 94587
Ph: (510) 324-7777
Fax: (510) 324-9300
Toll Free: (800) 23-RUNCO

RUNCO VIDEO-PRODUCT INFORMATION
RETAIN THIS INFORMATION FOR YOUR RECORDS

Model Purchased

Date

Serial Number

Runco Authorized Dealer Name

Address

City

State/Province

Postal Code

Phone

Fax

Safety Precautions

Please read and retain these instructions for your safety. This unit has been engineered and manufactured to assure your personal safety, but improper use can result in potential electric shock or fire hazards. In order not to defeat the safeguards incorporated in this monitor, observe the following basic rules for its installation, use and servicing.

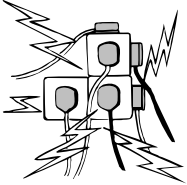

Do not allow anything to rest on the power cord. **Do not** locate this LCD monitor where the cord will be damaged by people walking on it.

Do not overload wall outlets and extension cords as this can result in fire or electric shock.

A suitable socket outlet must be provided near the monitor and be easily accessible.

Do not place this LCD monitor near any heat sources such as radiators, heaters, stoves and other heat-generating products (including amplifiers).

Do not place your LCD monitor on an unstable stand, shelf or table. Serious bodily injury and/or damage to the LCD monitor may result if it should fall. Your sales person can recommend an approved wall mounting kit. A special wall mounting kit is available for this model. To prevent injury, the LCD monitor must be securely attached to the wall in accordance with the installation instructions provided with the mounting kit.

This LCD monitor should be operated only from the type of power source indicated on the monitor or as indicated in the Operating Instructions. If you are not sure of the type of power supply, consult your sales person or your local power company.

For added protection it is strongly recommended that this LCD monitor is supplied via an approved earth fault protection device.

IMPORTANT: This product must be earthed

This unit is not disconnected from the mains unless the mains lead is unplugged. The installer must make sure that the waterproof inline coupler is easily accessible.

This monitor is tested to **IP56** standard rating. It is **not** protected against temporary or continuous immersion in liquid.

Do not use immediately after moving the LCD monitor from a low temperature to a high temperature environment, as this causes condensation, which may result in fire, electric shock, or other hazards. Before cleaning, unplug the monitor from the wall socket.

Do not mount near an open flame source. Open flames must never be used near this LCD monitor.

This LCD monitor should not be built in or enclosed in any way. Heat build up will reduce the life of the monitor.

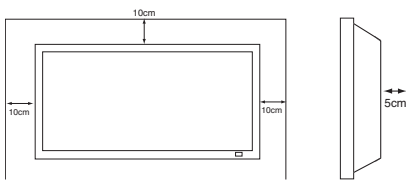

This LCD monitor should have a minimum distance of 5cm away from the wall and the monitor should have 10cm distance around the top and sides.

Always mount using recommended and substantial fixtures and fittings.

The rear finned section around the cabinet functions as a heat sink, removing heat away from the monitor. The external surface of the cabinet (finned area) must not be covered or the airflow restricted in anyway by enclosing the LCD monitor.

The operating temperature range of this monitor is guaranteed 0 °C ~ 40 °C (32 °F ~104 °F). It is not recommended to install the screen in direct sunlight without adequate shading, as this will cause the temperature of the panel to rise above the maximum specified.

Doing so may cause a black shadow to appear on the screen, which will disappear when the screen temperature returns to within the specification. This, of course, does not produce any harmful effect on the lifetime.

Do not apply liquid cleaners or aerosol cleaners directly onto the LCD monitor. Use a damp cloth for cleaning.

ADDITIONAL FOR NORTH AMERICA AND CANADA:

This monitor must **NOT** be permanently mounted to the building structure. It must be mounted in such a way that it can be removed using basic tools.

The power supply cord must **NOT** be attached to the building surface. The power supply cord must **NOT** be routed through walls, ceiling, floors, or other similar openings in the building structure.

The power supply cord **MUST** be positioned so as to prevent physical damage.

IMPORTANT (UK only):

THIS PRODUCT MUST BE EARTHED

This equipment is fitted with an approved, inline waterproof mains coupler and an approved, non-rewireable UK mains plug. To change a fuse in this type of plug, proceed as follows:

1. Remove the fuse cover and fuse.
2. Fit a new fuse which should be a BS1362 13 Amp A.S.T.A. or BSI approved type.
3. Ensure that the fuse cover is correctly refitted.

If the fuse cover is lost or damaged the plug must **NOT** be used but replaced with a serviceable plug.

If the fitted plug is not suitable for your socket outlets, it should be cut off and an appropriate plug fitted in its place. If the mains plug contains a fuse, this should have a rating of 13 Amp. Ensure the fuse cover is correctly fitted. If a plug without a fuse is used, the fuse at the distribution board should not be greater than 13 Amp.

The severed plug must be destroyed to avoid a possible shock hazard should it be inserted into a 13 Amp socket elsewhere.

The wires in this mains lead are coloured in accordance with the following code:
Blue = Neutral; Brown = Live; Green and Yellow = Earth

1. The Blue wire must be connected to the terminal which is marked with the letter "N" or coloured BLACK.
2. The Brown wire must be connected to the terminal with the letter "L" or coloured RED.
3. The Green and Yellow wire must be connected to the terminal which is marked with the letter "E" or coloured GREEN or GREEN and YELLOW.

Before replacing the plug cover, make certain that the cord grip is clamped over the sheath of the lead - not simply over the wires.

Do not attempt to bypass the safety purpose of the grounding type plug.

**THIS UNIT IS NOT DISCONNECTED FROM THE MAINS UNLESS THE MAINS LEAD IS UNPLUGGED.
THE INSTALLER MUST MAKE SURE THE WATERPROOF INLINE COUPLER IS EASILY ACCESSIBLE.**

SERVICING:



Your monitor is fully transistorised and does not contain any user-serviceable components.



You must not remove the rear cover of the monitor by yourself. The apparatus is working with high voltages and could damage objects or even endanger people. Leave all required repair and service jobs to an authorised service technician. He will exclusively use such spare parts that are complying with the same safety standards as applicable to the original parts. The use of original spare parts can prevent fire, shock and other hazards.

Unplug the LCD monitor from the wall outlet and refer servicing to qualified service personnel under the following conditions:

- If the power cord or plug is damaged.
- If liquid has been spilled into the LCD monitor.
- If the LCD monitor has been dropped or the cabinet has been damaged.
- If the LCD monitor exhibits a distinct change in performance.
- If the LCD monitor does not operate normally by following the operating instructions.

Adjust only those controls that are covered in the operating instructions as improper adjustment of other controls may result in damage. This will often require extensive work by a qualified technician to restore the monitor to normal operation.

IMPORTANT RECYCLING INFORMATION



Lamp(s) inside this product contain mercury. This product may contain other electronic waste that can be hazardous if not disposed of properly. Recycle or dispose in accordance with local, state, or federal Laws.

For more information, contact the Electronic Industries Alliance at WWW.EIAE.ORG.

For lamp specific disposal information check WWW.LAMPRECYCLE.ORG.



Your Runco product is designed and manufactured with high quality materials and components which can be recycled and reused.

This symbol means that electrical and electronic equipment, at their end-of-life, should be disposed of separately.

In the European Union there are separate collection systems for used electrical and electronic products.

Please help us to conserve the environment we live in!

Note: This symbol mark and recycle system are applied only to EU countries are not applied to other countries of the world.

DECLARATION OF CONFORMITY (North America and Canada):

Model Number: WP-42HD

Trade name: Runco

Responsible party: Planar Systems, Inc.

Address: 1195 NW Compton Drive, Beaverton, OR 97006

Telephone: +(866) PLANAR1

This device complies with Part 15 of the FCC Rules. Operation is subject to the following two conditions:

- (1) this device may not cause harmful interference, and
- (2) this device must accept any interference received, including interference that may cause undesired operation.

AC POWER CORD REQUIREMENT:

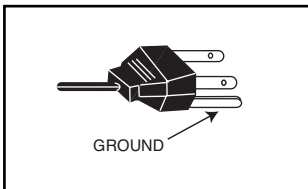

The AC Power Cord supplied with this LCD monitor meets the requirement for use in the country in which you purchase it.

AC Power Cord for the United States and Canada:

The AC Power Cord used in the United States and Canada is listed by the Underwriters Laboratories (UL) and certified by the Canadian Standard Association (CSA).

The AC Power Cord has a grounding-type AC line plug. This is a safety feature to make sure that the plug will fit into the power outlet. Do not try to defeat this safety feature. Should you be unable to insert the plug into the outlet, contact your electrician.

THE SOCKET-OUTLET SHOULD BE INSTALLED NEAR THE EQUIPMENT AND EASILY ACCESSIBLE

END-USER LICENSE:

The product (meaning the equipment or appliance to which this documentation relates) incorporates Software (the software applications, utilities and modules embedded within the Product) which is owned by Runco or its licensors. Before using the product, please read the End-User License Conditions detailed below. If you do not agree to the terms and conditions of the End-User License, please do not proceed to use the Product; repack the Product unused and return it to your supplier together with proof of purchase for a full refund. By using the product, you agree to be bound by the terms and conditions of the End-User License.

License Grant, Conditions and Restrictions

1. Runco grants you a non-exclusive, world-wide (subject to export controls), non-transferable (except as permitted by 2 below), royalty-free license to use the Software upon and with the Product.
2. You may not transfer any of your license rights in the Software without the prior written consent of Runco and if consent is provided then the Software shall only be transferred in conjunction with the transfer of the Product AND provided that the transferee has read and agreed to accept the terms and conditions of this license.
3. You must ensure that the copyright, trademark and other protective notices contained in the Software are maintained and not altered or removed.
4. The Software provided hereunder is copyrighted and licensed (not sold). Runco especially does not transfer title or ownership rights in the Software to you. The Software provided hereunder may contain or be derived from portions of materials provided to Runco under license by a third party supplier.

5. Except as expressly permitted by statute, **you may not**;

- use the Software in conjunction with any other computer hardware other than the product;
- copy all or part of the Software;
- incorporate all (or any of) the Software into other programs developed by (or on behalf of) you and/or used by you;
- reverse-engineer, decompile or disassemble the Software;
- make the Software (or any part of it) available, or permit its redistribution, for use with any computer hardware other than the Product; or rent, lease, gift, loan, sell, distribute or transfer possession of the whole or any part of the Software.

Termination

This license is effective until terminated. This license will terminate automatically without notice if you fail to comply with any of its provisions.

Disclaimer

1. The Software is (to the extent permitted by law) supplied “as is” and Runco and its suppliers expressly exclude all warranties, express or implied, including (but not limited to) warranties of satisfactory quality, fitness for purpose and non-infringement (save to the extent that the same are not capable of exclusion at law).
2. In no circumstances will Runco be liable for any direct, indirect, consequential, or incidental damage (including loss of profits, business interruption, loss of data or the cost of procurement of substitute goods, technology or services) arising out of the use or the inability to use the Software (save to the extent that such liability is not capable of exclusion at law).

General

1. This End-User License will be governed by laws of England and the User may only bring claims in the English Courts and Runco shall be entitled to bring a claim in the courts of any jurisdiction.
2. This End-User License is governed by the laws of the State of California. The End-User and Runco agree that any action to enforce or interpret the terms of this End-User License shall be brought only in the appropriate state or federal court located in Los Angeles County, California. The End-User and Runco hereby submit to the exclusive jurisdiction and venue of such court.
3. The above terms and conditions supersede any prior agreement, oral or written, between you and Runco relating to the Software.

Table of Contents

ONE YEAR LIMITED WARRANTYiii
Safety Precautionsvi
1. Installation1
Connections to the WP-42HD1
RS-232 Controller Connection3
2. Operation5
Remote Control5
Remote Control Operation5
Battery Installation6
Turning on the Power6
Controls and Indicators7
Menu Operation8
Main Menu9
Picture9
Picture Menu (PC)10
Sound11
Setting11
Setting Menu (PC)12
Installation13
Screen Mode15
3. Helpful Hints17
4. Serial Communications19
RS-232 Connection and Port Configuration19
Setting the Monitor Address in RS232 Mode19
Serial Command Syntax20
5. Specifications23
WP-42HD Specifications23
Computer/Video Signal Support24

Notes:

1. Installation

1.1 Connections to the WP-42HD

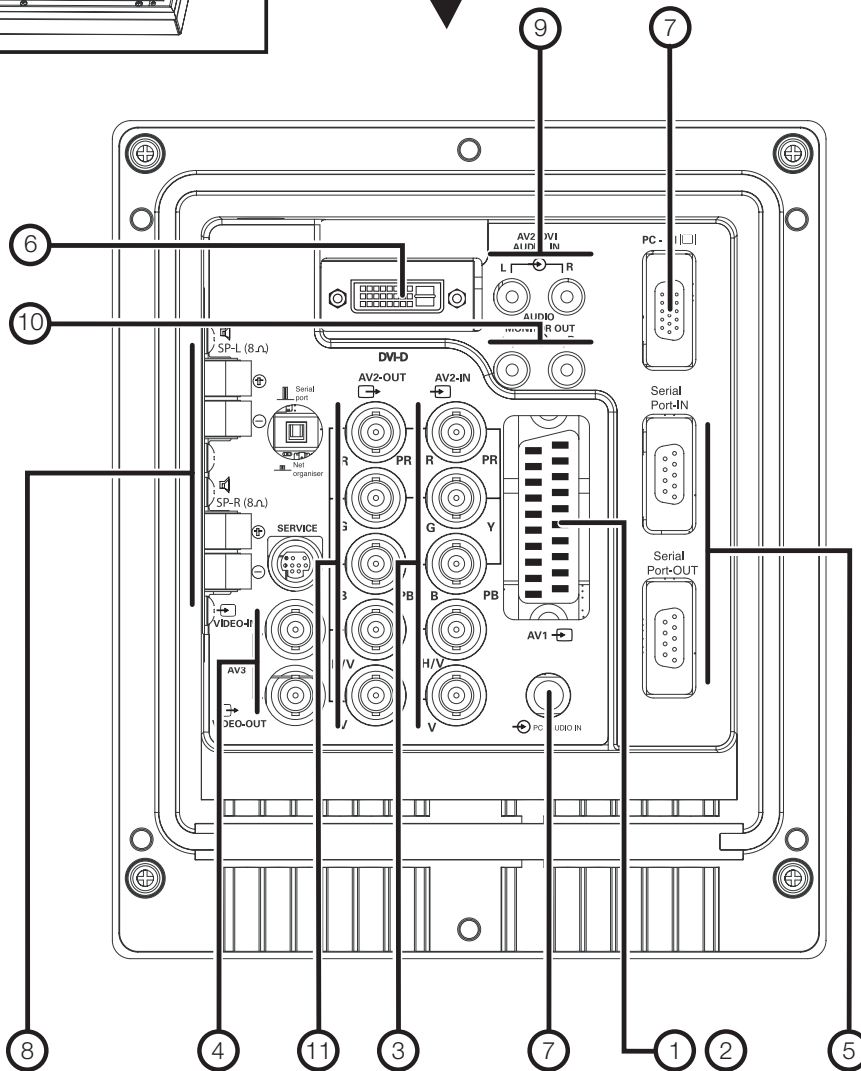
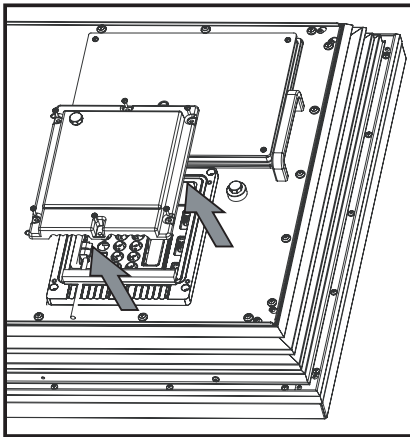

1. **AV1**
SCART connection.
2. **RGB**
TTL input (5V RGB signals) into SCART terminal.
3. **AV2 (Y,Pb,Pr/ RGBHV connection)**
This LCD monitor has a choice of Y, Pb, Pr or RGB H/V connections. You can connect your DVD player to the Y, Pb, Pr terminals instead of using a SCART lead. This can support high definition in analogue component form. RGB H/V can be used as a PC input via the BNC terminals. Both options support a large range of resolutions (page 24).
4. **AV3**
Composite (CVBS) signal input
AV3 OUT is to output the composite video signal from the VIDEO IN so that you can connect monitors with the use of a loop through function.
5. **RS232C IN/OUT**
Input for external commands to control the monitor (page 19).
6. **DVI-D (Digital Video Interface)**
This monitor has an DVI connector. This is located at the back of the monitor next to the phono sockets. This input will support a large range of resolutions as shown on page 24. See page 8 for details of menu operation.
7. **PC connection**
This LCD monitor has a PC connector (PC-IN D-SUB). You can connect a PC to the LCD monitor and use it as a monitor display (see page 10). Audio can be connected via the 3.5mm PC audio in socket. This input will support a large range of resolutions (see page 24).
8. **Speaker Outputs**
To output the audio signal from AV 1,2,3, PC and DVI. The speaker impedance should be 8 ohms.
9. **AV2/DVI Audio Input**
10. **Audio Monitor Out**
The audio monitor out sockets on the rear of the set provide a fixed level audio output for reproducing sound via your audio equipment.
11. **AV2 Video Output**
AV2 OUT is to output the Y, Pb, Pr or RGB H/V video signal from the AV2 IN so that you can connect monitors with the use of a loop through function.

Use a “null-modem” (cross-over) RS-232 cable with a 9-pin, female connector to connect a PC or home theater control/automation system (if present) to the RS-232 port on the WP-42HD. **RS-232 Controller Connection**

For more information about using this connection, refer to **Serial Communications** on page 19.

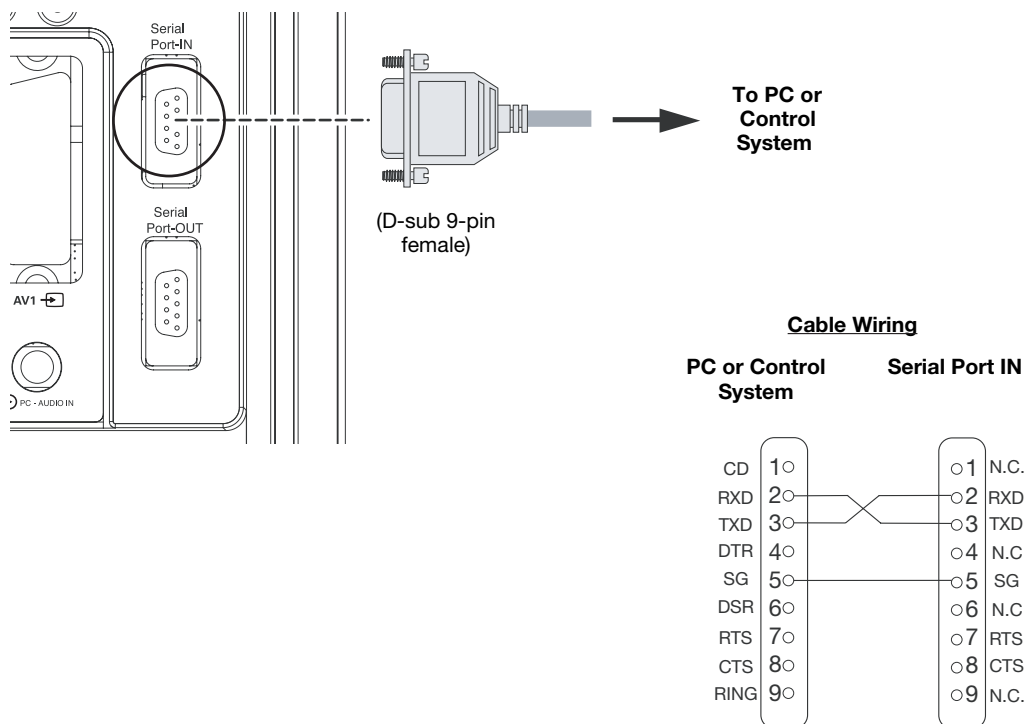

Notes:

2. Operation

2.1 Remote Control

◀ Remote Control Operation

1. TV/AV

Press repeatedly to scroll through all inputs (AV1, RGB, AV2, AV3, PC or DVI). Or, press and hold for a few seconds, then use **P▲** or **P▼** (see below) to select an input from an on-screen list.

2. STANDBY

Press to turn the monitor on or off.

3. WIDE

Press to select a screen mode: Natural, Full, Zoom, Title-in, or Normal.

4. RECALL

Press to display program information or to select a colour system when using the AV1, AV2 or AV3 input (AUTO, PAL, SECAM or NTSC 3.58).

5. MENU

Press to enter and exit sub-menus.

6. **P▲** / **P▼**

Press to select a menu item.

7. /

Press to adjust the sound volume level or enter a sub-menu.

8. (Mute)

Press to mute the sound from the speakers.

9. (Picture Mode selection)

Press repeatedly to select a picture mode:

Personal: Personal preference mode.

Dynamic: Suitable for brightly-lit areas.

Standard: Normal viewing mode.

Eco: Suitable for dimly-lit rooms; creates a cinema-like effect.

10. BASS

Press to turn Bass Expander on or off. Bass Expander emphasises low frequencies.

11. SURROUND

Press to select the Surround mode (OFF, MID or MAX).

12. Press and hold for five seconds to access the Installation menu (refer to page 13).

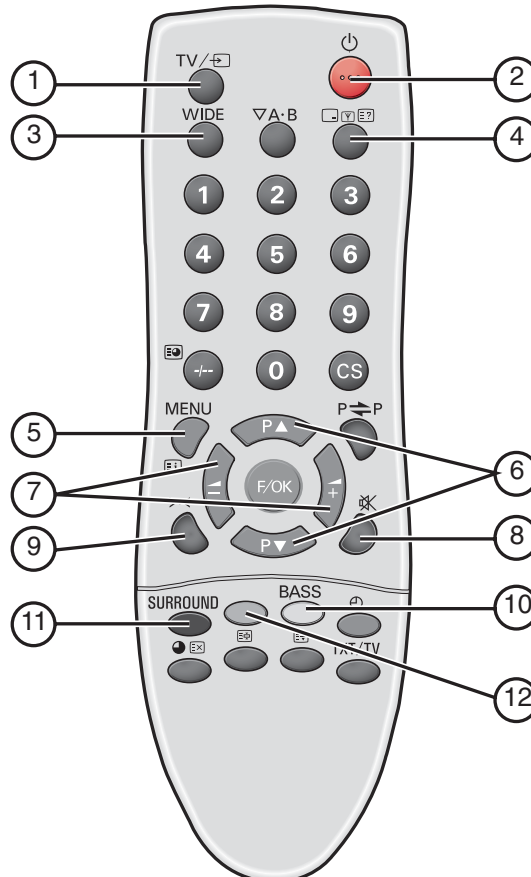

- Battery Installation** ➤ Install two, "AA" 1.5-volt batteries into the remote control unit so that the ⊕ and ⊖ marks on the batteries match the ⊕ and ⊖ marks inside the unit.

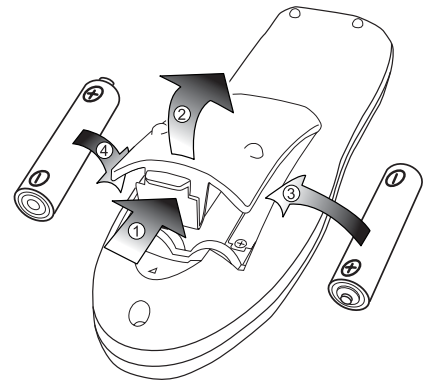

2.2 Turning on the Power

1. Turn on your source components.
2. Connect the in-line power connector to the mains coupler at the rear of the WP-42HD (AC 100V ~ 240V, 50/60 Hz).

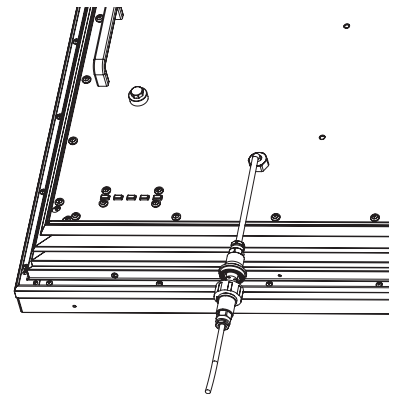

3. Connect the power cord of the LCD monitor to a wall outlet. (Use the correct mains lead supplied with the set for your area.)

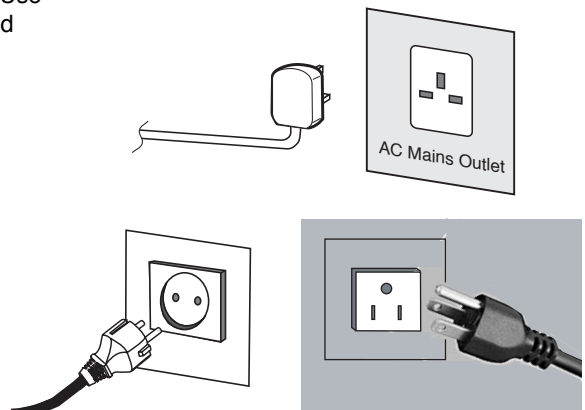

Note

As this product does not have a mains On/Off switch, please ensure your mains plug is easily accessible.



The LCD monitor is prepared for a mains voltage AC100~240V, 50Hz/60Hz. To completely switch off the mains, or when the display unit is not to be used for an extended period of time, it is advisable to disconnect the power cord from the power outlet.



WARNING

To prevent injury, the unit must be securely attached to the wall in accordance with the installation instructions provided with the wall-mount kit.

High voltages are used in the operation of this set. Refer service to qualified service personnel.

4. Press the **STANDBY**  button on the remote control to turn on the display (or press the power  button at the rear of the display).

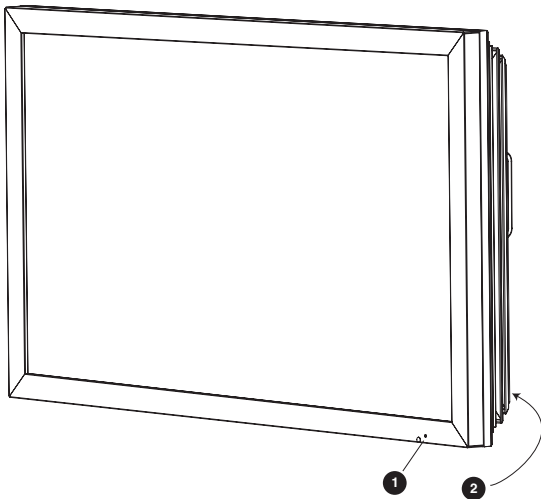
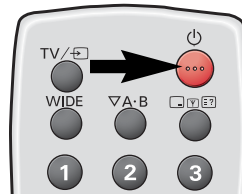



← **Controls and indicators**

1. Standby LED

The WP-42HD has a Standby LED to show there is power.

Switching into/from standby mode: The Standby mode is used for switching the LCD monitor off for short periods of time. In standby mode the monitor is switched off but is still receiving mains power.

To turn the monitor into standby mode, press the  button. The blue power indicator illuminates more brightly.

To turn the monitor ON from standby mode, press any of the following buttons: , **P▲**, **P▼** or **0 - 9** buttons.

2. Control buttons (bottom corner of back cover)

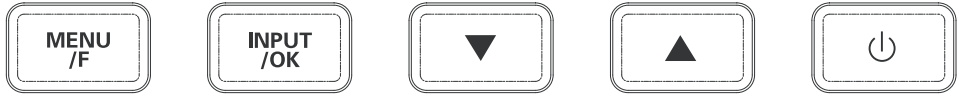

MENU/F: rotate between Volume, Brightness, Contrast, Colour, Sharpness and OSD language.

INPUT/OK: switch between AV1, RGB, AV2, AV3, DVI and PC mode.

▲ ▼: provide up and down adjustments.

⏻ (Standby): Press to switch from display to standby mode (to switch off completely, disconnect the monitor from the power supply).

2.1 Remote Control

Many functions are controlled through the menu function, using the remote control handset.

During menu operation, the bottom of the on-screen display shows which controls can be used for menu navigation.

Press the **MENU** button to enter the main menu.

When the input signal is RGBHV (AV2/PC mode):

Picture	Brightness	
	Contrast	
	Color	
	Sharpness	
	Preset	Personal / Dynamic / Standard / Eco
	Noise Reduction	Min / Mid / Max / Auto / OFF
	Dyn. Skin Tone	ON / OFF
Sound	Text Brightness	Min / Mid / Max
	Volume	
	Balance	
	Bass	
	Treble	
Setting	Preset	Personal / Talk / Music / Normal
	Surround	OFF / Mid / Max
	OSD Language	English / French / German / Italian / Spanish / Dutch
	Timer	5, 10, 15 ... 120 min. or OFF
	Text Language	Greek / East / West / Cyrillic
Installation	AV2 Setting	RGBHV / YPbPr
	ON Program	OFF / AV1-AV3 / RGB / DVI / PC
	Max Volume	
	OSD	ON / OFF
	Winter Mode	ON / OFF
	RC Inhibition	ON / OFF
	Child Lock	ON / OFF
	Address	000 ... 999
Baud Rate	9600 / 19200	

Picture	Brightness	
	Contrast	
	Position	
	Video Adjust	
	Auto Adjust	
	Resolution	
	White Tone (R / G / B)	
Sound	Native Resolution	
	Volume	
	Balance	
	Bass	
	Treble	
Setting	Preset	Personal / Talk / Music / Normal
	Surround	OFF / Mid / Max
	OSD Language	English / French / German / Italian / Spanish / Dutch
	Timer	5, 10, 15 ... 120 min. or OFF
	AV2 Setting	RGBHV / YPbPr
Installation	Power Save	ON / OFF
	ON Program	OFF / AV1-AV3 / RGB / DVI / PC
	Max Volume	
	OSD	ON / OFF
	Winter Mode	ON / OFF
	RC Inhibition	ON / OFF
	Child Lock	ON / OFF
	Address	000 ... 999
Baud Rate	9600 / 19200	

A sub-menu is selected using the ▲ or ▼ button and pressing the ◀+ button when the required sub-menu is highlighted.

◀ **Main Menu**

When you have finished you can press the **MENU** button to exit, then the **MENU** button again to exit the main menu.

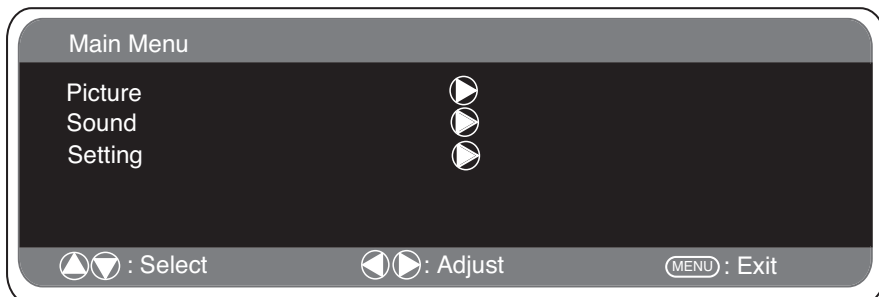

◀ **Picture**

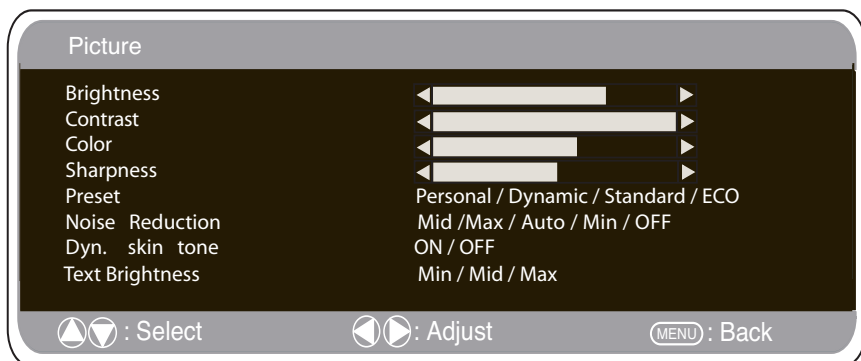

1. Press the **MENU** button. Select Picture using the ▲ or ▼ button. Press the button to enter. Set the picture settings for your “personal” preference.
2. Use the ▲ or ▼ button to select eg. Brightness and the ◀+ / ▶- button to adjust levels.

Preset: You can select either your “Personal” settings, or Dynamic, Standard or Eco settings.

Noise Reduction: May be used to reduce any local picture “noise” (granular appearance) being experienced by using ◀+ / ▶- to select between Mid / Max / Auto / OFF / Min.

Dyn. Skin Tone: May be used to enhance skin tone by using ◀+ / ▶- to select between On/Off.

Tint: Tint is only available if NTSC equipment is connected. or

Text Brightness: May be adjusted by using ◀+ / ▶- button to select between Min / Mid / Max.

Press the **MENU** button to return to Main Menu. These settings automatically store when you exit the menu. Press the **MENU** button again to exit the Main Menu.

Picture Menu (PC) ➤ Connect your PC to either PC-IN or RGBHV on the rear of the set. Then, select PC mode or AV2 (RGBHV) via the TV/☐ button on your remote control. The set will become a monitor for the PC.

By pressing the **MENU** button on the remote control a menu window will appear on screen, this allows the settings to be adjusted.

To adjust the Picture settings select Picture using the ▲ or ▼ buttons on the remote then the ◀+ button to enter the following picture settings menu.

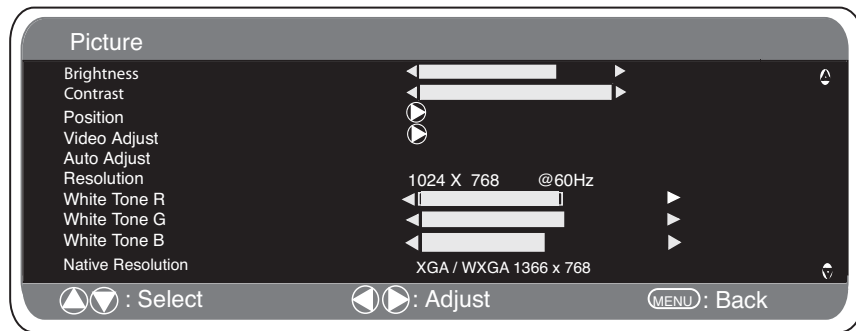

Press the ◀- or ▶+ buttons to adjust the Picture brightness and the same to adjust the contrast of the picture.

Position: Picture position changes the picture horizontally or vertically. Press the ▶+ button to enter the sub menus, adjustment is carried out using the ◀- or ▶+ buttons on the remote control.

Video Adjust: Video adjust changes the Phase and the clock of the screen. If the picture is blurred or grainy this function will adjust it to a clearer picture, adjustment is carried out using the ◀- or ▶+ buttons on the remote control.

Auto Adjust: Auto Adjust will automatically adjust the picture by using the ▶+ button. This will change all the above settings automatically.

Auto adjust can also be achieved by pressing the ☐▼☐ (recall) button on the remote control without having to select the menu.

Resolution: Resolution displays the current resolution of the picture. This is for information only and cannot be adjusted.

White Tone (R / G / B): Using the ◀- or ▶+ buttons it is possible to adjust the colour tone of the picture using the White Tone Red(R) / Green (G) / Blue(B). This will adjust the picture to show more or less of the chosen colour. For example, if red is selected you can adjust the proportion of red in the picture to increase or decrease using the ◀- or ▶+ buttons.

Native Resolution: Native Resolution is used when the PC can output WXGA 1366 x 768. The setting on your Monitor set can be changed to receive XGA/WXGA signal using the ◀- or ▶+ buttons. Once the native resolution has been selected, save the settings by switching the monitor off then on using the standby button.

Press the **MENU** button and select Sound using the **P▲** or **P▼** buttons, press the **▲+** button to enter. **◀ Sound**

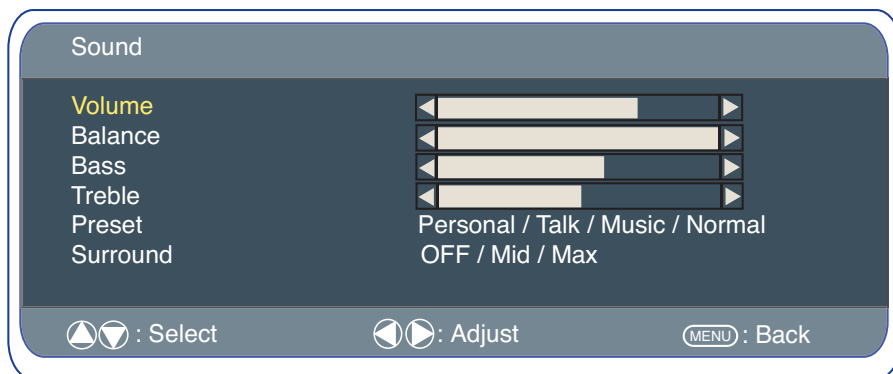

Select and adjust to obtain the best sound settings for your environment using the **P▲** or **P▼** and **◀-** or **▲+** buttons.

Press the **MENU** button to return to Main Menu. These settings automatically store when you exit the menu. Press the **MENU** button again to exit the menu.

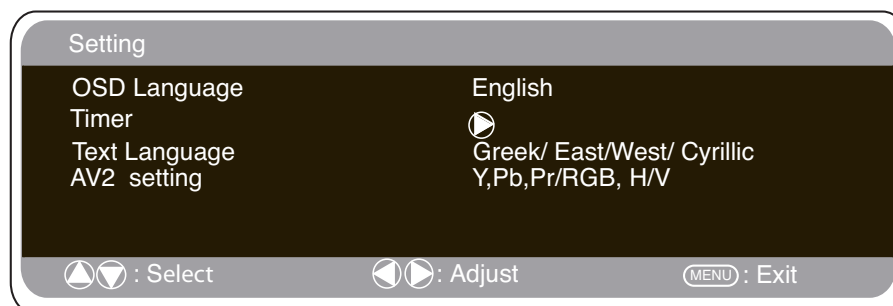

◀ Setting

OSD Language: Use the **◀-** or **▲+** button to select the preferred OSD language (French, German, Italian, Spanish, Dutch). Press the **MENU** button to exit.

Timer: The Off timer will switch the monitor into the standby mode when the selected time has elapsed.

1. Press the **MENU** button. Select Setting using the **P▲** or **P▼** button and press the **▲+** button to enter.

2. Select Timer using the **P▲** or **P▼** button and press the **▲+** button to enter.



3. Press the **◀-** or **▲+** button to change time.

The time changes in 5-minute steps. The maximum time is 120 minutes.

If you have set the off timer, a count down display appears in the corner of the screen when the recall button is pressed.



Note

If the monitor is switched off by the standby button  on the remote control or by the standby switch  on the bottom of the LCD monitor, the timer settings will be cancelled.

AV2 Setting: In setting menu, to select AV2 press the **P▼** button and set to Y,Pb,Pr or RGB, H/V depending on your external equipment.

1. Press the **MENU** button. Select Setting using the **P▲** or **P▼** button. Press the **▲+** button to enter.
2. Select AV2 Setting using the **P▲** or **P▼** button.
3. Press the **▲-** or **▲+** button to select either Y,Pb,Pr or RGB H/V.
4. Press the **MENU** button to exit. This automatically stores your changes.
5. Press the **MENU** button again to exit.

Setting Menu (PC) ► Press the menu button on your remote and use the **P▲** or **P▼** button to select Settings. The **▲+** button will enter the settings menu.

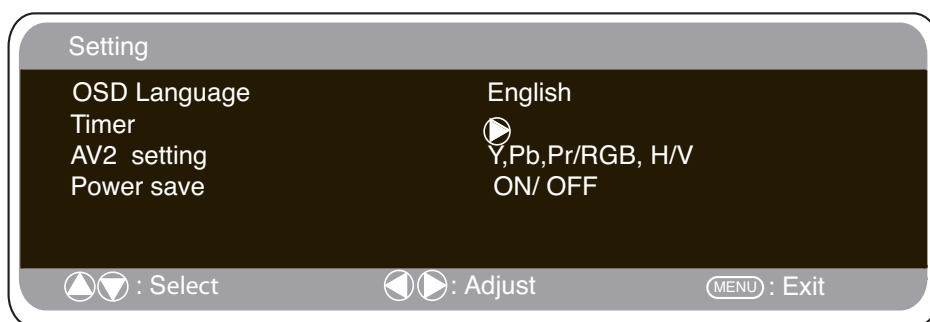

OSD Language, Timer and AV2 Setting are the same as in all other input modes (refer to page 11).

Power Save: Power save if turned ON will switch the monitor into Powersave mode after 1 minute if no signal is detected, the LED light will turn a brighter blue to indicate stand by. The monitor will automatically turn back on when a signal has been detected (PC input / RGBHV).

Use the **▲-** or **▲+** buttons to select power save ON or OFF.

This LCD monitor allows you to set up the following.

◀ Installation

SETTING PROCEDURE:

1. Press and hold the green button on the remote control handset for 5 seconds. Installation menu will appear.



Note

The green button is next to the SURROUND button (refer to page 5).

2. Use the **P▲** or **P▼** button to highlight each option, use the **◀-** or **▶+** to switch between each option.

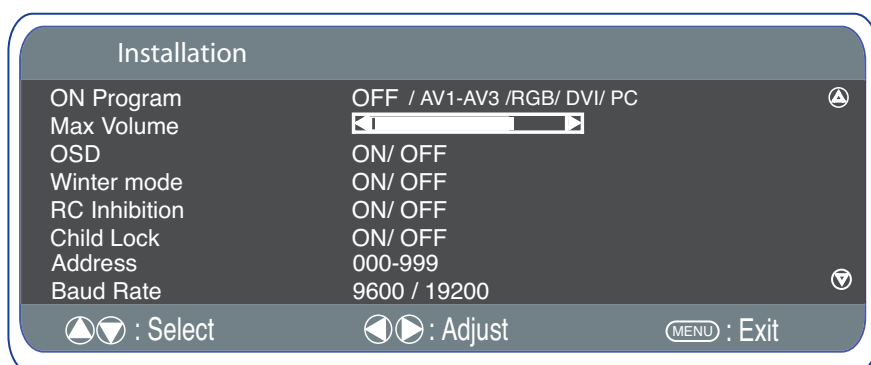

ON Program: Select ON Program using the **P▼** button, select the start up position using the **◀-** or **▶+** buttons. (Off / AV1 / RGB/ AV2/ AV3/ DVI/ PC)

Press the **MENU** button to exit the menu.

Max Volume: Select Max Volume using the **P▼** button, use the **◀-** or **▶+** buttons to set the maximum volume required.

OSD (On-Screen Display): Select OSD using the **P▼** button, select ON / OFF using the **◀-** or **▶+** buttons. Selecting OFF will inhibit the OSD. To reinstate OSD, press and hold the green button on the remote control to re-enter Installation menu and select OSD ON.

Winter Mode: This Function can be activated when the LCD monitor is used during cold temperature conditions (approximately +38°F/+4°C or below) to maintain picture performance.

Using the **P▲** or **P▼** button select winter mode, once highlighted you can select ON or OFF by pressing the **◀-** or **▶+** button.

IMPORTANT: The AC cord should not be disconnected during the operation of Winter Mode function.

When in winter mode, power consumption is higher than normal standby consumption. This is entirely due to the operation of heating circuitry. We strongly recommend to turn off Winter mode when the ambient temperature is above +38°F/+4°C.

RC Inhibition: You can prevent unwanted remote control operation by selecting RC Inhibition. When selected an inhibit symbol will appear on screen when a button is pressed on the remote control.

Select using the **P▲** or **P▼** button. Press the **◀-** or **▶+** button to select ON or OFF.

To re-instate RC operation, press and hold the green button on the remote control and select RC inhibition OFF.

Child Lock: You can prevent unwanted operation of the LCD monitor via the buttons on the bottom edge of the monitor.

Select using the **P▲** or **P▼** button. Press the button to select ON or OFF.



Note

Disconnecting the mains supply will cancel this feature.

Address: Each monitor can have a specific address; for example 007, which enables the monitor to be controlled individually without affecting other monitors connected to a controlling PC.

Select Address using the **P▼** button. Set the address using the **◀-** or **▶+** buttons.

The address range is 000 - 999. The default address is 000.

Baud Rate: The baud rate indicates the unit for transfer speed of data from the PC to the monitor sets.



Note

With the default address setting, the serial control port is disabled. In order to control the WP-42HD with a PC or control system, you must change the address to something other than 000.

*For more information about controlling the WP-42HD using a PC or control system, refer to **Serial Communications** on page 19.*

Today there are various transmission formats with different size ratios; for example, 4:3, 16:9 and video formats such as Letterbox.

◀ **Screen Mode**

Press the **WIDE** button repeatedly to select your desired setting.



Note When in High Resolution (720p/1080i) YPbPr or DVI, the picture will remain fixed in 16:9 format “full size” and may not be changed.

■ **Natural**

4:3	14:9	16:9	Letterbox Video
Stretches the picture horizontally to fill the screen. The picture is more stretched at the edges.	The height is expanded to fill the whole screen.	The picture fills the screen and is proportionally correct.	The black bars top and bottom remain and the height is compressed to fit the picture area.

■ **Zoom**

4:3	14:9	16:9	Letterbox Video
The correct picture width is maintained but the top and bottom are cropped.	Zooms in slightly cropping the top and bottom.	Zooms in slightly cropping the top and bottom.	The black bars top and bottom are smaller and the picture height is compressed slightly.

■ **Title - In**

4:3	14:9	16:9	Letterbox Video
As zoom (14:9), but bottom is compressed even more to allow subtitles to be seen.	As zoom (14:9), but bottom is compressed even more to allow subtitles to be seen.	As zoom (14:9), but bottom is compressed even more to allow subtitles to be seen.	As zoom (14:9), but bottom is compressed even more to allow subtitles to be seen.

■ **Full**

4:3	14:9	16:9	Letterbox Video
The whole screen is filled stretching the width.	The whole screen is filled stretching the height slightly at the edges.	The whole screen is filled with the correct picture ratio.	The black bars top and bottom are present and the height is compressed.

■ **Normal**

4:3	14:9	16:9	Letterbox Video
The correct ratio is maintained with black bars on the left and right.	Black bars left and right, picture height is stretched.	Black bars left and right, picture height is stretched.	Black bars left, right, top and bottom.

Notes:

3. Helpful Hints

Symptom	Solution
NO PICTURE, NO SOUND	<ul style="list-style-type: none">• Check if monitor is plugged in.• Check monitor is not in standby mode
POOR PICTURE, SOUND OK	<ul style="list-style-type: none">• Adjust BRIGHTNESS/ contrast levels (too low).
NO COLOUR, PICTURE OK	<ul style="list-style-type: none">• Adjust COLOUR control• Check lead connections• Does the signal input have colour?
REMOTE CONTROL DOES NOT WORK	<ul style="list-style-type: none">• Check batteries are inserted correctly• Check condition of batteries• Check to see if remote control inhibit is set to ON
PICTURE OK, NO SOUND	<ul style="list-style-type: none">• Check external speakers are connected correctly• Check lead connections to external equipment• Volume turned down or mute selected

Notes:

4. Serial Communications

The WP-42HD can interface with a home theater automation/control system or a PC running terminal emulation software. Connect it to your control system or PC as shown on page 3. (Use a null-modem cable.)

Configure the RS-232 controller or PC serial port as follows: no parity, 8 data bits, 1 stop bit and no flow control. Set the baud rate to match that of the WP-42HD RS-232 port (9600 or 19200).

To check the baud rate setting, select Baud Rate from the Installation menu (refer to page 14).

Each monitor can have a specific address; for example 007, which enables the monitor to be controlled individually without affecting other monitors connected to a controlling PC.

To set the monitor address, select Address from the Installation menu (refer to page 14)

Address Command Format: The addressing command format is used for operating multiple monitor sets from a single PC via the RS232C command line. If you set your monitor address to "000," it will never respond to any addressing command from the PC. If the address from the PC is "FFF," all monitor sets will execute the command.



Note

With the default address setting, the serial control port is disabled. In order to control the WP-42HD with a PC or control system, you must change the address to something other than 000.

The Address format command is defined by one command, one line which starts with A and ends with carriage return (0x0D).

The Monitor starts to decode when it receives a carriage return.

An address is added at the top of a control command.

Example:

Functional execution command:

A001C05<CR> means address is 001 and the control command is C05.

Status read command:

A001CR0<CR> means address is 001 and command is CR0.

4.1 RS-232 Connection and Port Configuration

4.2 Setting the Monitor Address in RS232 Mode

4.3 Serial Command Syntax

Commands begin with a C followed by one or more characters and ending with a carriage return (<CR> or 0x0D). A carriage return is required after **each** command.

The WP-42HD supports two types of commands:

- **Functional execution commands** that affect the operation of the monitor; for example, C01<CR> turns the monitor off.
- **Status read commands** that provide monitor status information; for example, CR1<CR> returns the currently-selected input.

Table 4-1 lists the RS-232 command set.

Table 4-1. Serial Commands

Command	Description
Function Commands	
C00	Power ON
C01	Power OFF
C23	Wide "Auto" direct
C24	Wide "Natural" direct
C29	Wide "Full" direct
C0F	Wide "Normal" direct
C30	Toggle Picture Mode (Dynamic, Standard, Eco or Personal)
C70	AV1 direct
C71	RGB direct
C72	AV2 RGBHV direct
C73	AV2 YPbPr direct
C74	AV3 direct
C75	DVI direct
C76	PC direct
C64	PC Auto adjust
C92	Factory settings
CF PSAVE ON	Power Save ON
CF PSAVE OFF	Power Save OFF
CF CLOK ON	Child Lock ON
CF CLOK OFF	Child Lock OFF
CF DEA RMCY	RC Inhibition OFF
CF DEA RMCN	RC Inhibition ON

Table 4-1. Serial Commands (continued)

Command	Description
Status Read Commands	
CR0	Power (On, Standby, Power Error)
CR1	Current Input (AV1, AV2, AV3, DVI or PC)
CR WIDE	Wide Mode (Auto, Normal, Natural or Full)
CR PICTURE	Picture mode (Dynamic, Standard, Eco or Personal)
CR SIGNAL	Signal existence (Signal/No Signal)
CR CHILD	Child Lock (On/Off)
CR PSAVE	Power Save (On/Off)
CR TM	Panel operating time

Notes:

5. Specifications

Table 5-1 lists the WP-42HD specifications

5.1 WP-42HD Specifications

Table 5-1. WP-42HD Specifications

Display Native Resolution:	1366 x 768
Screen Size:	42 in. (1066,8 mm) diagonal
Screen Aspect Ratio:	16:9
Colour System:	PAL/NTSC3.5/SECAM
Contrast Ratio:	1500:1
Data/Graphics Compatability:	Refer to Table 5-2 and Table 5-4
Response Time:	6 ms
DTV Compatability:	Refer to table 5-3
Vivix Processing:	3:2 or 2:2 pull down
Inputs:	AV1: SCART CENELEC Standard; Composite video, RGB (+5V RGB with +5V sync to pin 14) and L/R Audio AV2: 5 x BNC; RGBHV/Component Video and L/R Audio AV3: BNC, Composite Video DVI Input: DVI-D GROUP Standard PC Input: Mini D-Sub 15-pin and Audio 3.5mm jack
Outputs:	RGBHV/Component Video (AV2) Composite Video (AV3) L/R Audio (MONITOR OUT RCA pair)
Audio System:	6W RMS x 2 Stereo Amplifier
Power Requirements:	100 to 240 VAC, 50/60Hz
Power Consumption:	195 watts at 100V / 184 watts at 240V
Operating Environment:	-4 °F to 104 °F (-20 °C to 40 °C); IP56 Protected 20% to 80% humidity (non-condensing)
Dimensions (W x H x D):	1027.0mm x 620mm x 167.5mm (40,43 in. x 24,41 in. x 6,59 in.)
Weight :	85.4 lbs. (38 8 kg)
Regulatory Approvals:	EN60950 2002 EN55022 1998+A2 and EN55024 1998+A2 EN61000-3/2-2000 EN61000-3/3-1995+A1 2001 UL60950 2002 CAN/CSA-C22.2 FCC part15 Class B, UL Listed
Limited Warranty:	One (1) year parts and labor from the date of the delivery to the end user.

Specifications are subject to change without notice.

5.2 Computer/Video Signal Support

Table 5-2. Supported PC Signal Timings

Resolution	Horizontal Frequency (kHz)	Vertical Frequency (Hz)	Remark
720_400	31.47	70.09	DOS (VGA)
640_480	31.50	60.00	DOS (VGA VESA 60Hz)
640_480	37.50	75.00	VGA VESA 75Hz
640_480	37.86	72.81	VGA VESA 70Hz
640_480	37.86	74.38	VGA
640_480	35.00	67.00	Mac.
640_480	34.97	66.60	Mac LC 13"
800_600	35.16	56.25	SVGA VESA 56Hz
800_600	37.90	60.32	SVGA VESA 60Hz
800_600	46.90	75.00	SVGA VESA 75Hz
800_600	32.70	51.09	SVGA
800_600	34.50	55.38	SVGA
800_600	37.90	61.03	SVGA
800_600	38.00	60.51	SVGA
800_600	38.60	60.31	SVGA
832_624	49.00	74.00	Mac.
1024_768	48.40	60.00	XGA VESA 60Hz
1024_768	56.50	70.00	XGA VESA 70Hz
1024_768	60.000	75.00	XGA VESA 75Hz
1024_768	44.00	54.58	XGA
1024_768	46.90	58.20	XGA
1024_768	47.00	58.30	XGA
1024_768	48.50	60.02	XGA
1024_768	58.03	72.00	XGA
1024_768	60.31	74.92	XGA
1024_768	61.00	75.70	XGA
1024_768	60.24	75.08	MAC_Normal 19"
1280_960	60.00	60.00	SXGA VESA 60Hz
1280_1024	79.976	75.025	SXGA VESA 75Hz
1280_1024	62.50	58.60	SXGA

Table 5-2. Supported PC Signal Timings (continued)

Resolution	Horizontal Frequency (kHz)	Vertical Frequency (Hz)	Remark
1280_1024	63.370	60.01	SXGA
1280_1024	63.34	59.98	SXGA
1280_1024	63.74	60.01	SXGA
1280_1024	63.79	60.18	SXGA
1280_1024	63.90	60.00	SXGA
1280_1024	71.69	67.19	SXGA
1280_1024	76.97	72.00	SXGA
1280_1024	81.13	76.107	SXGA
1152_864	64.20	70.40	SXGA
1152_900	61.20	65.20	SXGA
1152_900	61.85	66.00	SXGA
1152_900	71.40	75.60	SXGA
1152_870	68.68	75.06	Mac_Normal 21"
1280_960	75.00	75.08	Mac
1280_1024	80.00	75.00	Mac
1600_1200	75.00	60.00	UXGA VESA 60Hz
1366_768	48.36	60.00	WXGA
1360_768	47.70	60.00	WXGA

Table 5-3. Supported Component Video Signal Timings

Resolution	Horizontal Frequency (kHz)	Vertical Frequency (Hz)	Remark
720x480	15.735	60i	SDTV 480i
720x576	15.625	50i	SDTV 576i
720x480	31.25	60p	SDTV 480p
720x576	31.25	50p	DTV 576p
1280x720	45.00	60p	HDTV 720p
1280x720	37.50	50p	HDTV 720p
1920x1080	33.75	60i	HDTV 1080i
1920x1080	28.13	50i	HDTV 1080i

Table 5-4. Supported DVI-D Video Signal Timings

Resolution	Horizontal Frequency (kHz)	Vertical Frequency (Hz)	Remark
640_480	31.43	59.88	VGA VESA 60Hz
640_480	37.86	72.81	VGA VESA 72Hz
640_480	37.5	75	VGA VESA 75Hz
640_480	34.97	66.6	Mac LC 13"
640_480	35	66.67	MAC_Normal 13"
800_600	35.16	56.25	SVGA VESA 56Hz
800_600	37.88	60.32	SVGA VESA 60Hz
800_600	46.875	75	SVGA VESA 75Hz
720_480	31.7	59.94	480p
768_575	31.25	50	575p
1280_720	37.5	50	720p-50Hz
1280_720	45	60	720p-60Hz
1920_1080	28.125	50	1080i-50Hz
1920_1080	33.75	60	1080i-60Hz

Note: Depending on the condition of signals and the type and length of cables, these signals may not be properly viewed.



SERIAL NUMBER
020-0711-00 Rev. A
October 2007